

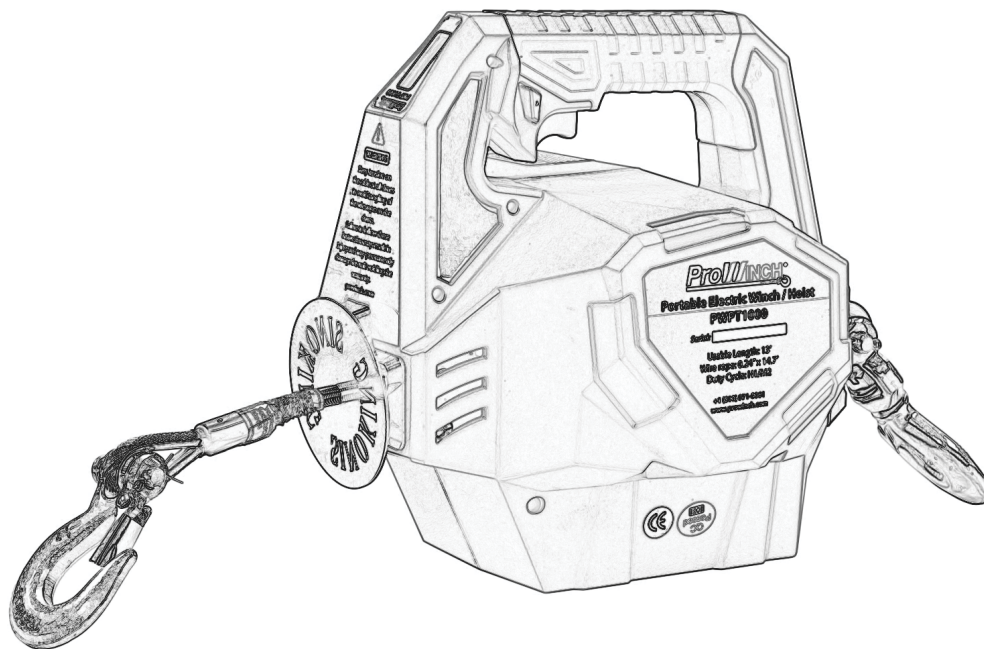

Portable Electric Winch Hoist 500 lbs. Rechargeable Battery Powered Wireless

User's Manual / Manual de usuario
Safety Warnings / Advertencias de Seguridad



PROPERTY REGISTRY N° 189487
ANY REPRODUCTION IS FORBIDDEN
PROPERTY OF PROWINCH® 2018 - V8.0 ALL RIGHTS RESERVED
PROWINCH LLC COMPANY WITH QUALITY MANAGEMENT SYSTEM

PROWINCH® DISCLAIMER

Prowinch® LLC declares that it has made available to the Customer each and every one of the security warnings related to the purchased product and that, as a result, it does not assume any responsibility for any damages or losses that may be suffered by the client or third parties, cause or as a direct or indirect consequence of the breach or omission of any of the instructions or safety warnings contained in the User Manual and Security Warnings corresponding to the unit purchased.

In this sense, Prowinch® LLC will not be liable for accidents and / or damages to persons and / or property resulting from the negligent use of the product. In no case does Prowinch® LLC assume any liability arising from the use of these voluntary recommendations, and does not offer any guarantee in relation to them. These recommendations do not take precedence over the current safety regulations of the plant. For purposes of enforcing the Warranty of the product purchased, Prowinch® LLC, will only be liable for any damage when it is possible to prove that the user has followed each and every one of the warnings contained in the User Manual and Safety Warnings.

1. It is the sole responsibility of the Client / User to verify that the acquired equipment, products and accessories comply with the characteristics, capacities, requirements, components, accessories and other conditions for the use that the Client / user intends to give it.

2. It is also the sole responsibility of the Client / User to ensure that the equipment and products purchased are operated and maintained with adequate safety standards and by personnel duly trained in the use thereof. The Client / User is also responsible for implementing all the security measures necessary to prevent accidents or damages to people or property and for following the indications and warnings of the corresponding manual.

3. Any assistance provided by Prowinch® LLC in the selection of the equipment, the capacities and characteristics required by the clients is delivered free of charge and based on the information about the application, use and requirements indicated by the Client itself. It does not correspond to Prowinch® LLC to verify the accuracy of the given information. It is the sole and exclusive responsibility of the Client -or who will use the equipment and products acquired- to ensure that the specifications comply with the capabilities, characteristics, up-to-date maintenance and everything necessary for a correct and safe operation in relation to the intended use.

4. Prowinch® LLC recommends the use of winches with 4 brakes for personnel lifting. The use of winches of 3 brakes or less or safety features lower than the best available for personnel lifting, is the sole responsibility of the customer in order to guarantee the safety of the personnel and users of the equipment it is necessary to carry out the inspections

and maintenance of the equipment according to the recommended frequency in relation to its work cycle. It is mandatory to keep record and evidence the written and photographic reports of: Maintenance, Start-up, Load Tests, Training, Certifications, Inspections and Reports of failures and accidents.

5. The aforementioned reports must be sent by email to registros@prowinch.com within the first 7 calendar days after the occurrence of an event.

6. Compliance with the timely implementation of the mandatory activities described in points 6 and 7 in addition to all the activities mentioned in the corresponding rules applied are the sole responsibility of the user. Failure to comply with the foregoing conditions releases Prowinch® LLC from any type of Liability and Warranty to the team, customer, staff or user, or any other liability that could be attributed to Prowinch® LLC.

7. The information contained in this manual may contain technical errors or inaccuracies. Prowinch® LLC is not responsible for typing errors, omission or incorrect information.

8. This manual is subject to change without prior notice. Download the latest version available at www.prowinch.com.

9. Always check www.prowinch.com for the latest information regarding this product.

This page intentionally left blank



- 1. Portable Winch
- 2. Wireless
- 3. Hook
- 4. Charger

PWPT1000-500lb

Wireless Control System Prowinch 500 lbs Portable Electric Winch / Hoist with Wireless Remote Control Battery Powered comes standard with one Li-ion Rechargeable battery and a Wireless / Pendant control. Total wire rope length 13'. Cooling System The cooling fan of this Electric Winch / Hoist is specifically designed to achieve quick heat dissipation, with rates of up to 12% of continuous labor. Braking System Electromagnetic brake system designed to automatically engage on any power cut-off.



- 1. Variable Speed Switch
- 2. Direction Switch
- 3. Power Switch
- 4. Swiveling Anchor Hook
- 5. T 1.0 Display Screen
- 6. Stopping Plate
- 7. Charging Dock
- 8. Wire rope
- 9. Battery

Thank you for purchasing our Prowinch® Electric Winch/Hoist. This User Manual provides important information for personnel involved with installation, operation, and maintenance of this product. Read this User Manual before installing, operating, or maintaining product.

SAFETY PRECAUTIONS

Prowinch® Electric Winch Hoist is designed for safe and reliable service if operated according to User Manual. Respect all warnings for personnel and third party safety. Inadequate operation may cause injuries or damage equipment. Read and understand this User Manual carefully before installation and commission of equipment. Keep this User Manual in an accessible place for consultation.

This User Manual highlights symbols and notes for caution, warning and danger. Attention to these areas ensures safety of operator.

Mandatory use of:



Hard Hat



Safety Glasses



Safety Gloves



Safety Shoes

Safety Precautions

WARNING:

This symbol indicates unsafe practices or situations which may cause damage to the property and even injuries to the personnel.



DANGER:

This symbol indicates a potentially dangerous situation which if not avoided may cause severe injuries or death



DANGER

All operators and other users who are near the winch or its load must wear required safety equipment: gloves, safety helmet / hard hat, safety shoes and eye protection.

WARNING

Before installing, removing, inspecting, or performing any maintenance on the winche, the unit must be unplugged, locked out, and tagged out. Do not use this equipment in hazardous locations.

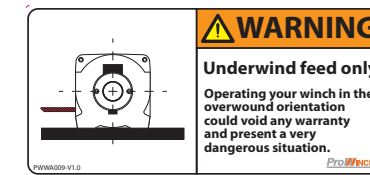

Read and understand the contents of this User Manual thoroughly before handling the product. Practicing correct and safe operating procedures and carrying out the recommended preventative maintenance will ensure a long, reliable, and safe service.

After carefully reading and understanding the User Manual, store it for future reference.



Before using equipment:

- Read and understand instructions in this User Manual and labels associated with winch hoist before operating equipment.
- Wear appropriate clothing: Do not wear jewelry or loose clothes as they might get attached to winch or hook.
- Wear leather gloves, cover any long hair.
- Wear non-slippery safety shoes, helmet, and eye protection.
- Perform full check of hoist. Check for damaged parts or unusual characteristics. Keep a safe distance: suggested distance is at least 1.5 times length of winch. Broken or loose winch may cause injuries or death.
- Check winch is properly lubricated.
- Secure electric winch/hoist to a suitable support.
- Visually inspect all electric winch in addition to regular and maintenance inspections

During Operation:

ALWAYS

- Refer to maximum load capacity displayed on ID plate of hoist, not capacity of hook.
- Stop operation immediately if unauthorized personnel enter working area.
- Check state of hoist: If engine gets too hot, stop hoist and let it cool for a while.
- Stop, check, and secure load if hoist stops or loses movement during operation.
- Focus on operation. Pay attention at all times and keep proper balance.
- Unplug hoist after operation.

NEVER

- Never pulling out cable over the red warning mark.
- Never operate this machine when under the influence of drugs, alcohol or medication.
- Never operate this pulling tool if you're under 16 years of age.
- Never apply load to hook tip or latch. Apply load only to center of hook.
- Never use a hook whose throat whose opening has increase, or whose tips is bent or twisted.
- Never attempt to tow a vehicle or object with the recovery strap attach directly to the pulling tool hook.
- Never use bungee straps that develop tremendous and potentially dangerous amounts of force when stretched.
- Never hook cable back onto itself. This will damage the cable.
- Never use pulling tool to lift load over people.

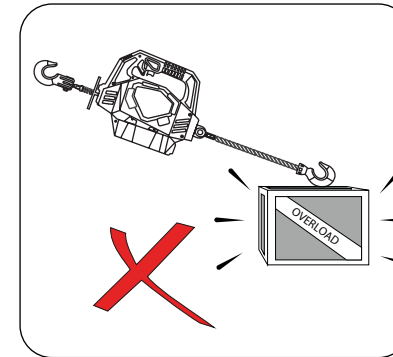

1. Do not exceed winch or winch rope rated capacity. Check the quality of the electrical

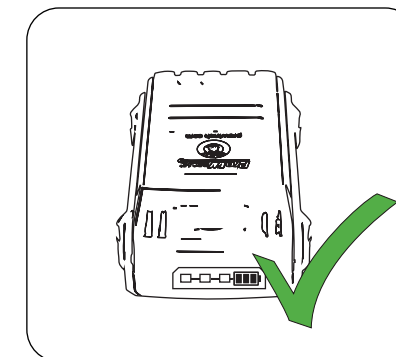

2. Keep the battery fully charged always.

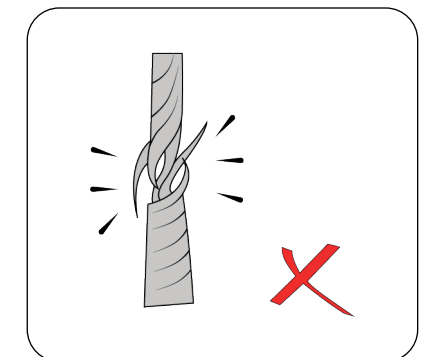

3. Always inspect winch rope, hook, and slings before operating winch. Frayed, kinked or damaged winch rope must be replaced immediately.



4. Do not use the equipment to lift or move people.

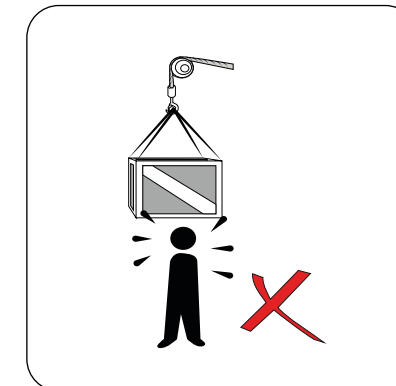

5. Do not stand under the load, it may fall and cause death

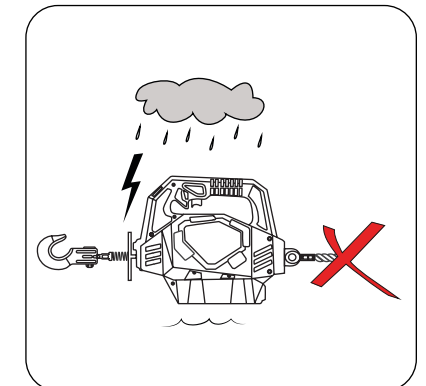

6. Do not submerge winch in water. Always store the remote control in protected, clean, dry area.

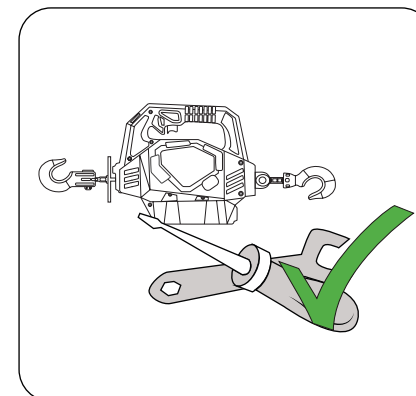

7. Perform preventive checks as part of a regular maintenance schedule to keep your winch operating properly.

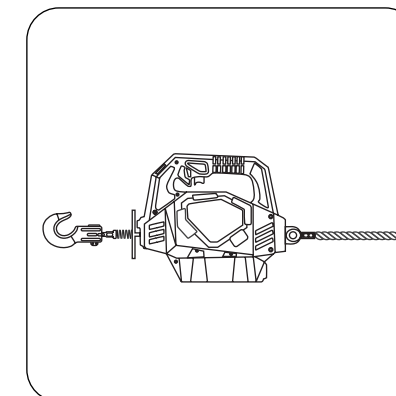

8. Always verify installation before operating.

ELECTRICAL HAZARD



- Never charge battery in damp or wet environment
- Always disconnect charger when battery is fully charged
- Never probe with conductive object
- Always fully charge battery before use
- Never completely discharge battery
- Always charge battery every six months if not in use
- Never operate the tool during charging
- Never leave the toll near heat sources
- Always use the provided charger battery
- Never operate the tool if there are any violent impact or damage
- Never use in the rain or wet environment to protect motor from water and muds
- never burn batteries

GENERAL ENVIRONMENTAL PRECAUTIONS

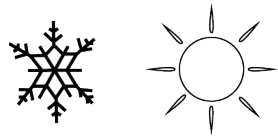

DANGER:

The following environmental conditions can cause malfunction of the winch.

The following environmental conditions may cause malfunctions in the equipment. When operated outdoor, a shelter should be used for extreme weather conditions: below -10° C or above 40° C

WARNINGS

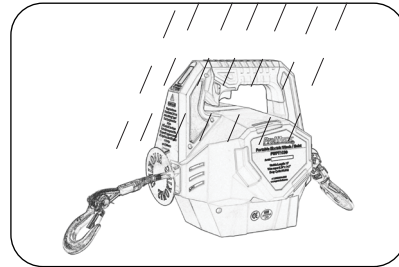

Avoid exposure to rain or snow. It may cause rusting of the equipment.

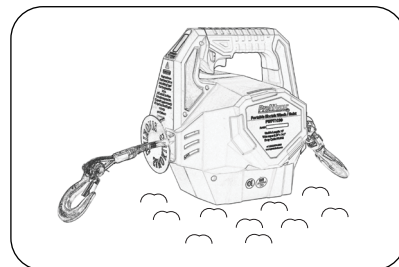

Exposure to sand may cause malfunctioning.

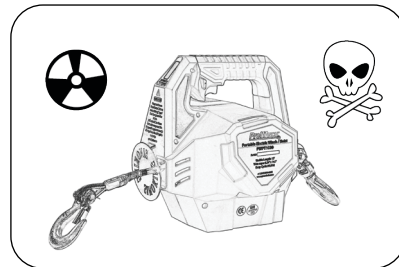

If used near chemicals, corrosive gas or explosives may cause an explosion. Exposure to salt or acids may cause malfunctioning.



FALLING OR CRUSHING

- Never attach recovery strap to the pulling tool hook to increase the length of a pull
- Always use a hook with a latch
- Always ensure hook latch is closed and not supporting load
- Never apply load to hook tip or latch. Apply load only to the center hook
- Never use a hook whose throat has increased, or whose tip is bent or twisted
- Never attempt to tow a vehicle or object with the recovery strap attached directly to the pulling tool hook
- Never use bungees straps that develop tremendous and potentially dangerous amounts of force when stretched
- Always avoid side pulls which can pile up cable at one end of the drum. This can damage cable or pulling tool.
- Never hook cable back onto itself. This will damage the cable
- Always use a chocker cable or strap: never use pulling tool to lift or move persons
- Never use pulling tool to lift load over people
- Always use suitable anchor point when handling load
- Never use pulling tool to secure a load
- Never shock load cable. Shock load can damage, overload and break cable
- Never use the pulling tool's cable to tow another load
- Vehicle or object collision during towing can exceed cable strength
- Always make sure the anchor you select will withstand the load and the strap will not slip
- Always take time to use appropriate rigging techniques for pulling / lifting
- Never spool out past length of red cable
- Never exceed pulling tool or cable capacity listed on product data sheet. Using a snatch block to reduce pulling tool load
- Never exceed 500 Lb (454Kg) Maximum pulling capacity
- Always use suitable anchor point capable of handling load
- Always rewind under tension load after use
- Tightly wound cable reduces chances of "binding" which can damage the cable
- Always wind the cable onto the drum in the direction specified by the product warning label on the product and/or documentation
- Always avoid turning switch and off while using this product. This can damage motor controls unit and cable

Operation Instructions

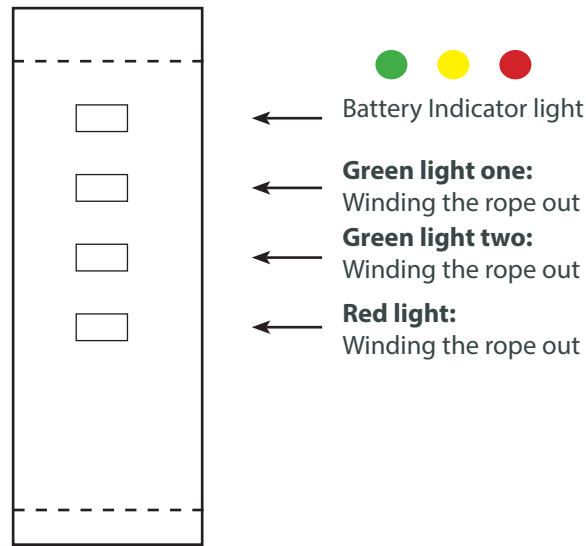

1. Press the power switch ("ON") of pulling tool, the display light is on. Press the direction switch "▲", "the green light one" light up, pulling tool is releasing the cable. Press the direction switch "▼" "the green light one" go out and "The green light two" light up. Pulling tool is in the winding mode.

2. Overload and overheating display

1. When the load reaches 90% of the maximum load, the red light lights up and flashes.
2. When the load reaches the maximum load, the "red light" light up, the product stop working and enter the protection mode.
3. When the battery temperature reaches the setting maximum operating temperature, the product will stop working and then enter the protection mode.
4. When the electric current is too big, the fuse will break, the "red light" light up, and the product stop working, please contact the costumer service for repair.

3. Battery power display

1. The battery indicator light has three colors.
2. When the indicator light is green, battery power is enough, and pulling tool can be used normally.
3. When the indicator light is yellow, we recommend you charge it before use.
4. When the indicator is red, the battery power is running out. Please charge as soon as possible.

4. Limit switch

During normal operation, the stopping switch is turned ON. When the stopping pate reached the upper limit switch, the operating signal will be ignored. Stop winding cable, when "red light" light up, reverse the operation direction.

T1000 Display Screen

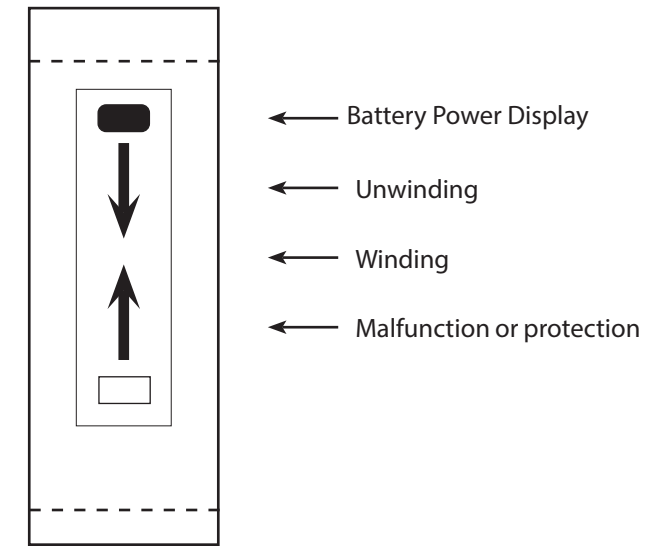

1. Display of battery power: five greeds are green. When the battery displays only one grid, please charge it soon.
2. Pulling out cable and winding back cable status indicator are displayed in green
3. When the red cope appears, please solve the problem according to the following table



ERROR CODE	PROBLEMS	SOLUTION
SIGN !	The load reaches 80% Of the setting load	Remind the user of the weight
CODE 1	Pulling tool stops working	The load reaches the setting protection load; you need to reduce the weight
CODE 2		The motor temperature reaches the maximum temperature; stop using pulling tool and let it cool to room temperature before using it again
CODE 3		Maximum current reached, fuse brakes; Please contact costumer service
CODE 4		Stopping limit reached; stop winding cable

4. When the battery temperature reaches the set temperature. the product stops working and enters the protection state.

Sometimes, the product will stop working because it has entered protection mode. At this point, please refer to the error code to reset the product.

Battery mount, status & charging

1. Battery installation and unloading

During the installation, please confirm that the power switch is at "OFF / O" position.

Battery release button must be at the top, align the contact point of the battery against the corresponding contact point on the battery slot, slide battery in, and gently press until the battery is locked in place.

When remove the battery from pulling tool, confirm the power switch is in the "OFF / O" position. Press down the battery release button and remove the battery.

2. Battery power

1. When the battery is installed in pulling tool, the battery status can be examined by opening pulling tool and looking at the battery frame in the display screen on the fuselage.

2. There is a power display button and three LED power indicator lights on the top of the battery. After pressing the button the battery status will be displayed:

1. Three LED lights are on and green, indicating a full battery.
2. One LED lights is off, the other two are green. If the indicator does not flicker, the power levels is between 40% and 70%.
3. When only one LED light is green, use it after charging.
4. If the indicator light is red, please charge as soon as possible.



3. Charge

You need to use the original charger to charge the battery, after the battery loaded into pulling tool, insert the power cord of the charger into power outlet, and the insert the plug of the charger into the charging port of pulling tool:

1. When the red light on the charger light up, the battery is charging.
2. When the red light turns green, battery has been fully charged. If the battery is not fully discharged, the light will turn green in a short time.

When the charger is not in use, please unplug the charger from the power outlet. A charger connected to the power outlet will consumes power even if it is not connected to pulling tool. The battery will be hot when charging, before using pulling tool, let the battery cool to room temperature.



Protection Functions

1. Short circuit protection:

The power value of short circuit protection: < 3W, the battery supply appliance can resume normal operation when the short circuit is fixed.

2. High current protection:

High current protection value: 1 < 1.8a, the power supply will automatically return to normal operation after current value return to normal.

Quick charging function:

The charger can fully charge a battery in two hours.

4. Charging note



- Make sure the machine is turned OFF when charging, this could avoid damaging the machine and battery.
- Never use pulling tool while charging.
- When the battery temperature higher than 158° F or below (-4° F), the battery will stop discharge in order to protect the battery, you need to wait for the battery to cool down to room temperature before using the product again.
- Please do not charge the battery when the ambient temperature is above 122°F or lower than 32°
- It takes two hours to charge. When the battery is fully charged, be sure to disconnect the charger.
- If the battery is flooded or damaged, it cannot be charged.
- Never charge or use battery in a dangerous environment, for example close to flammable liquids, gases or dust.
- Never store the battery in an extreme environment, or it will damage the battery.
- Never open the battery pack. If the battery pack is broken, please stop using it immediately, do not charge the battery and the replace the battery.
- While not using the machine, please place the power switch in OFF / o position to save power.
- Charge the battery before it runs out of power, which can help extend battery life.
- Disposal or recycling: please dispose of waste batteries according to local laws and regulations.



Please note these warnings above.

1. Insert other electrical equipment and check the voltage of the power outlet.
2. Confirm the charger voltage is about 29.4 VDC. See the charger pin here or on the charger label.
3. Check the battery terminal for dirt. If so clean with a cotton swab and alcohol.
4. If you still can not charge the battery, please contact the customer service.

Operation

Before using this machine to lift or pull a load, you should familiarize with your machine and it is important to know how it works.

This tool is a portable machine for lifting and pulling. This powerful tool has a power switch, a directional switch and a speed controller. The directional switch controls the forward and reverse rotation of the drum. The speed controller can change the speed when winding in or out.



When spooling out or rewinding the cable, it is necessary to keep a tension on the cable to prevent bind and entangle the cable, causing damage to it and the tool. Do not spool out anymore when you see the red paint on the cable.

Always keep at least 5 wraps of cable around the drum, avoid spooling the drum in the wrong direction. Never spool the cable out pass the red painted on the cable.

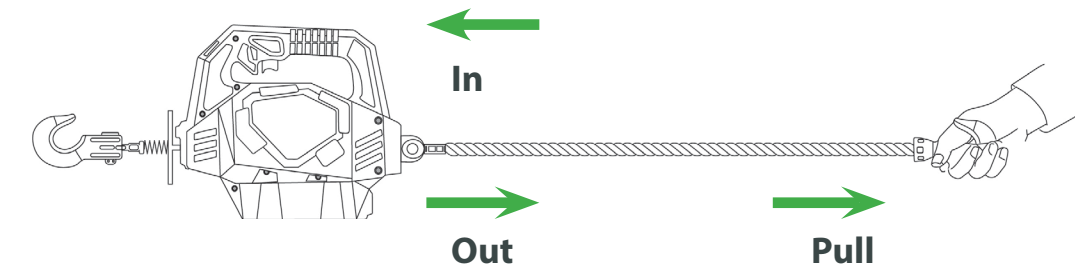

The following situations will cause the system entering the protection state automatically.

1. At 90% of the pulling capacity the overload indicator turns red
2. The battery is overheating
3. Low battery

When this occurs, please follow these steps:

1. Turn off the power switch
2. Remove the battery
3. Overload: Release the loading or increase the distance of the anchor point or use a snatch block to increase the pulling power.

Overheating: Allow the battery to cool to room temperature.

Low battery: Charge the battery

4. Install the battery back into the product
5. Turn on the power switch

The Equipment is ready to be operated again.

Operation

Take some time and practice using it before pull or lift a load, that way you will be familiar with all the operations.

The following steps describe how to use the tool with single cable. A snatch block can improve the pulling capacity.

1. Put on gloves and attach the strap to the hook.

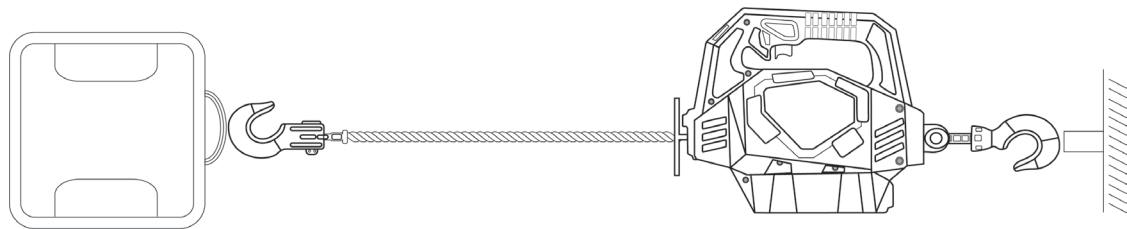

2. Install the battery. Make sure the position of power switch is at "OFF /O". Put the battery into this product, ensure the latch is fully engaged.
3. Power on the tool. Turn the power switch to the position "ON/I". Always turn the power switch to "OFF" when not in use.
4. Spool out. Press the directional switch to " " then press and hold the speed controller. Always keep some tension on the cable to prevent bind and entangle the cable, causing damage to it and the product. Never spool the cable out pass the red painted on the cable.
5. Secure and anchor point. Using the swiveling anchor hook to attach the anchor point. Always make sure that the anchor you intend to use is capable is withstanding the load. Never hook the cable onto itself. This could damage the cable. A tree saver or choker chain is recommended.
6. Attach you load. Establish a load point, use a shackle or strap when attaching the hook to your load. Always hook with a latch and insure hook latch is secure.
7. Give the cable some tension. Press the directional switch to " " then press and hold the speed controller to slowly wind the cable until the cable is winded tightly. Never touch cable or hook while in tension or under load.
8. Using a damper when pulling. When pulling, put a damper, blanket or other heavy-duty material over the cable.
9. Plan to pull or lift. Ensure all the connections are secured. Line up your pulling directions as straight as possible. Side pulls can cause the cable to bunch at one side of the drum, damage cable and the product.
10. Start pulling or lifting. Press the directional switch to " " then press and hold the speed controller to wind in the cable. Never exceed pulling capacity listed on product data sheet. Double the cable number using a snatch block to reduce load.

Operation

11. Disconnect the hook from load and anchor point. Be sure to secure the load completely. Press the directional switch to " " then press and hold the speed controller release tension in the cable. Disconnect the hook from the load and anchor point.

12. Rewind cable. Press the directional switch to " ", then press and hold the speed controller to slowly wind in the cable. Always keep a tension on the cable to prevent bind and entangle the cable, causing damage to it and the tool. Do not let cable slide through your hand.

13. Turn off the pulling tool. Make sure the position of power switch is "OFF /O" Store in a clean and dry place and avoid children to contact and play.

The operation is now complete.

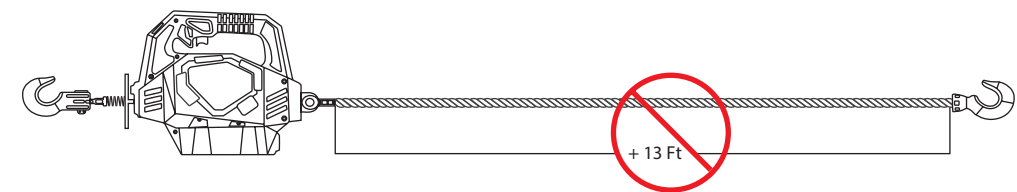
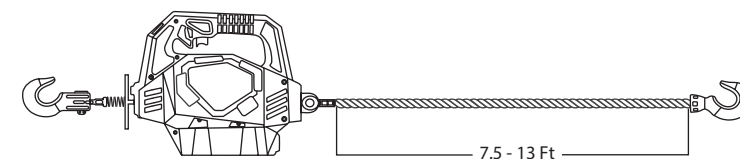
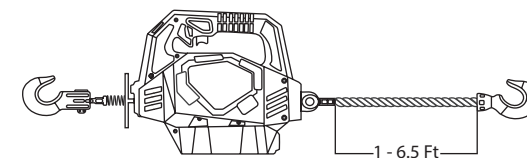

- Always spend some time check the load and determine whether the load is within the specified load range of the product.
- Always check the product for malfunction and battery status.
- Always wear gloves to prevent injury of hands caused by steel cables.
- Always pay attention to the safety of yourself and people around you.
- Practice over and over again.

Product Maintenance

When there are some problems with the machine, please follow the table to solve them.

Number	Problem	Solution to Malfunction
1	The product failure light (red light) light up and flashes.	It's normal phenomenon indicates the load reaches more than 80% of the rated load, which needs attention.
2	The product stop working, and the temperature is too high.	Stop using pulling tool until the motor cools to room temperature.
3	Product stop working	Please check the battery power. If power low, please charge it.
4	Product stop working (T1.0 red light up, T1000 display code)	Exceeds the rated load. try to reduce the load
5		The current is too big, resulting in the damaged fuse brakes need to replace the fuse or contact customer service.
6	Drum sound when laying or winding cable	The cables on the drum are wound together, you need pull the cable out and rewind it.
7	After operating according to charging requirements, the battery is still can't be charged.	Check the power socket problem. If so, replace the socket.
8		Check surrounding.
9		Check whether the charger and battery are faulty. If so, please purchase a new one or contact the Customer service.
10	Water damage	Return to factory for repair
11	Remove protection	Close the puling tool, unplug the battery, reload, And restart the machine

- Both pulling tool, accessories and cables must be carefully maintained to prevent damage and wear after use.
- If the cable is damaged, it is recommended not to use it. Replace it as soon as possible.
- It is very dangerous to use damaged cable. Before using, it is best to examine pulling tool and battery parts carefully.
- Battery components also need to be inspected or replaced regularly to make sure they are not damaged.

PROWINCH® WARRANTY

LIMITED WARRANTY COVERAGE

PROWINCH products are warranted to the original purchaser for a period of three (3) years after the date of purchase only to be free from defects in material and workmanship when subjected to normal, proper and intended use. Within this period, PROWINCH will only repair or replace free of charge any part on a product, after examination, is determined by PROWINCH to be defective in material or workmanship and was not caused or substantially contributed to by other factors or circumstances beyond PROWINCH control, including (but not limited to) defective installation, maintenance or repair, product modification or alteration, any neglect misuse or excessive use, mishandling, product exposure to extreme or unsuitable conditions, normal wear and tear or failure to follow manufacturer's instructions. This warranty does not apply to damage that PROWINCH determines to be from repairs made or attempted by anyone other than PROWINCH authorized personnel. Return of the product with a copy of proof of purchase to PROWINCH, freight prepaid and insured, are required for this warranty to be effective. If more than one year has elapsed from purchase date, proof of periodic and regular maintenance by an authorized service must also be provided for this warranty to be effective. PROWINCH does not cover freight or labor charges associated with the inspection and testing of products which are found by PROWINCH not to be a valid warranty claim.

PWPT1000-500lb

Portable Electric Winch Hoist 500 lbs. Rechargeable Battery Powered Wireless

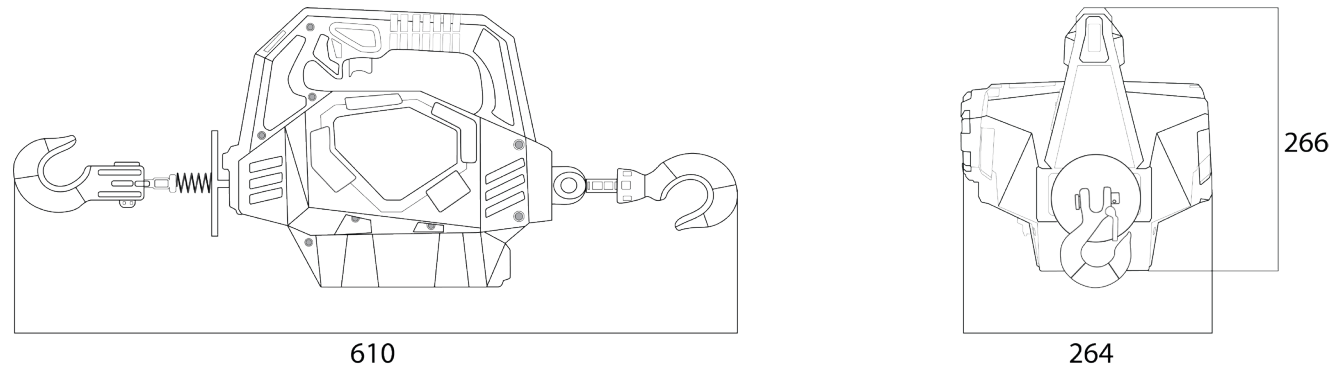

Dimensions in mm

PARAMETERS	SPECIFICATIONS
Rated Line Pulls	500 Lbs. (454 Kg)
Power Supply	25.2V DC
Cable	Ø6mm x 14.8 Ft
Battery	Lithium Battery
Battery Capacity	2.5 AH
Battery Charger Input	100-240V AC 50-60Hz 75W
Battery Charger Output	30V
Dimensions	24" x 10" x 10.5"
N.W.	17.2 Lbs

Pulling tool and accessories



Item Description	Quantity
Pulling Tool	1
Battery	1
Charger	1
Hook	1

PROWINCH LLC
www.prowinch.com

2901 NW 21st Terrace
Miami, FL 33142
United States
+1 (800) 971-8061

FORTIS ALLOY MEXICO
S.A. DE C.V
www.prowinch.mx

Fortis Alloy Mexico, S.A. de C.V.
Vicente Guerrero No. 403
Col. San Miguel, Apodaca,
Nuevo Leon,
Mexico C.P. 66649
+52 (81) 8244-1351

PROVEEDORA INDUSTRIAL
Y TECNICA, S.A. DE C.V.
www.prointe.com.sv

Av. Alberto Masferrer Sur, Col.
Campestre No. 211
San Salvador, El Salvador
2264-1100

Lima, Peru
www.prowinch.pe
+51 935402797

PROWINCH COLOMBIA SAS
www.prowinch.co
Cl. 163a #20-28,
Bogotá Colombia
(+57) 1 7034035

EQUIPOS DE IZAJE
PROWINCH CHILE SPA
www.prowinch.cl

Parque Riesco 3407, Recoleta,
Región Metropolitana, Chile
+56-2-26218989

