

# 1 Ton Underhung Motorized End Trucks Single Girder up to 57ft Span 220/440V 3P

## Características Esenciales

- I Beam and H Beam Compatible, Customizable up to 12" width Beams
- Kit Includes 2 End Trucks, 4 motors, 4 reducer, 4 Brakes
- Dual Voltage 220/440V 3 Phase, Optional Variable Speed Driver
- Fully Painted Orange RAL2009
- 3 Años de Garantía, Servicio y Atención al Cliente en Mexico

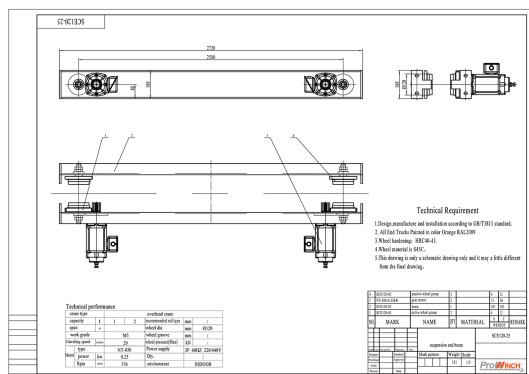

## Especificaciones Técnicas

<b>Capacidad de Carga</b>	1 ton	<b>Velocidad /min</b>	66 ft
<b>Numero de Velocidades</b>	1 Speed - Optional Variable Speed	<b>Voltaje</b>	3 Phase 220~240/440~480V 60Hz
<b>Potencia Total Watts</b>	0.25Kw x 4	<b>Luz Maxima</b>	70 ft
<b>Material</b>	Steel	<b>Clase de Servicio</b>	H4/M5/2m/Class D
<b>Freno Motor</b>	Yes	<b>Protección IEC Motor</b>	IP54
<b>Variador de Frecuencia</b>	Optional 1.5 Kw	<b>Freno Dinámico</b>	Only with VFD Optional
<b>Control</b>	Not Included. Optional single Speed, 2 Speed and Variable Speed	<b>Rango de ancho de la Viga</b>	110 - 300 mm (4.33 - 11.8 in)
<b>Normas</b>	ASME / CMAA / Nch	<b>Garantía</b>	3 Year

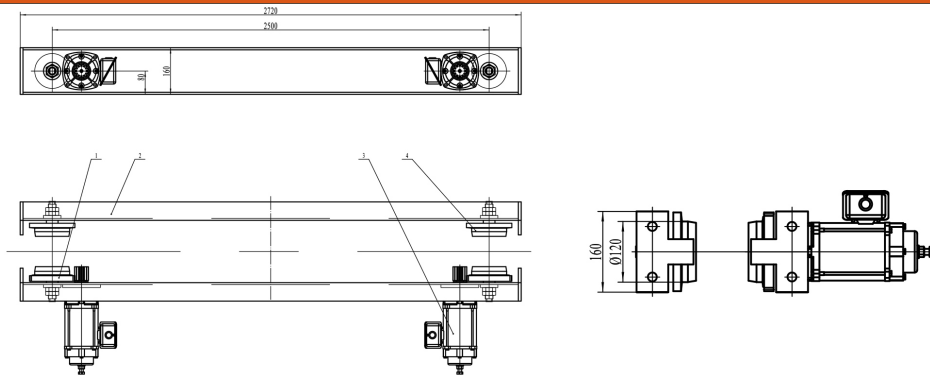

## Peso & Dimensiones

<b>Largo de testera</b>	2500 mm
<b>Peso Total</b>	392 lbs / 178 Kg

## Detalles del Empaque

<b>Paquete 1 Peso Bruto</b>	392 lbs / 178 Kg
-----------------------------	------------------

Referential Images / Imágenes Referenciales  
Specifications may change without notice / las especificaciones pueden cambiar sin previo aviso